

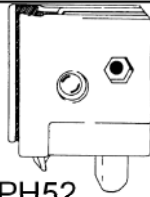

Products America PH59 Hardware Set

Plastic Hand Release System
800.205.9642 or 731.586.2100

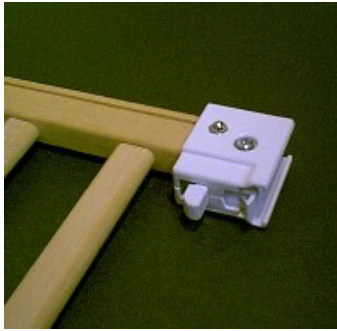

PH52
Top Lock
Box Type



AN124
Acorn Nut



MS8125
Attaching Screw

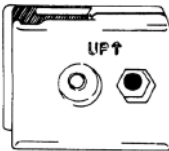

PH56
Lower Lock
Box Type



PH53
Upper Track



PH55
Lower Track

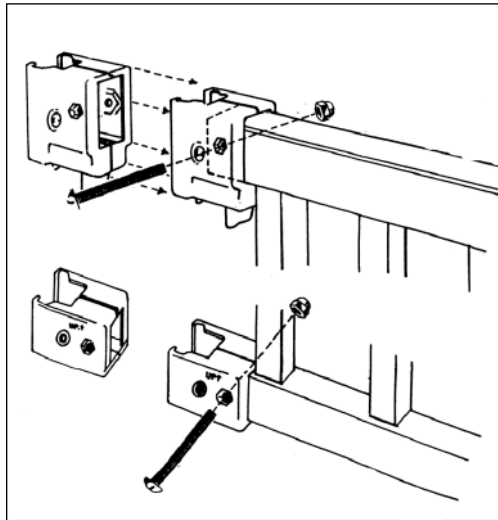

Application of PH59 series moving side plastic hardware.
NOTE: Installation of PH52 and PH56 onto drop side using MS8125 and AN124.

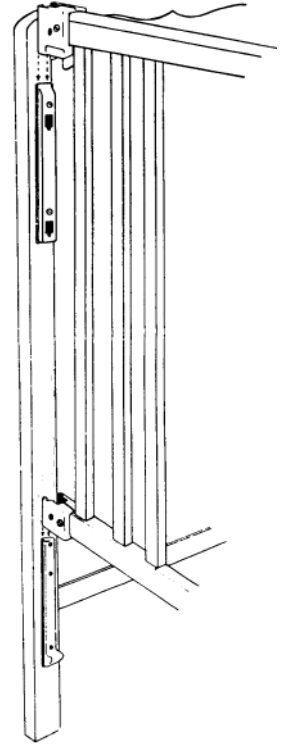

Products America PH50 Hardware Set

Plastic Hand Release System
800.205.9642 or 731.586.2100

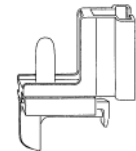

PH51
Top Lock
Claw Type



TWS811
Attaching Screw

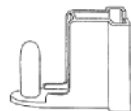

PH54
Top Lock
Claw Type



PH53
Upper Track



PH55
Lower Track

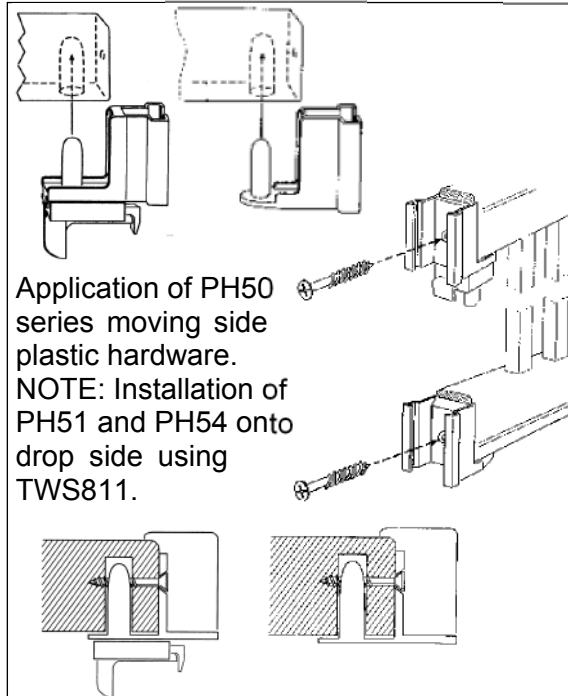

Application of PH50 series moving side plastic hardware.
NOTE: Installation of PH51 and PH54 onto drop side using TWS811.

